

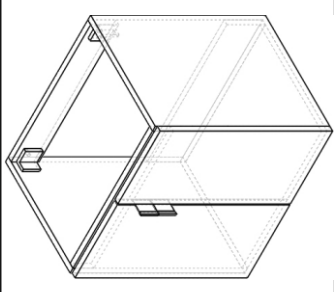

Instalacija mora biti urađena po normi DIN EN 14749
Nameštitev mora biti merojan po DIN EN 14749

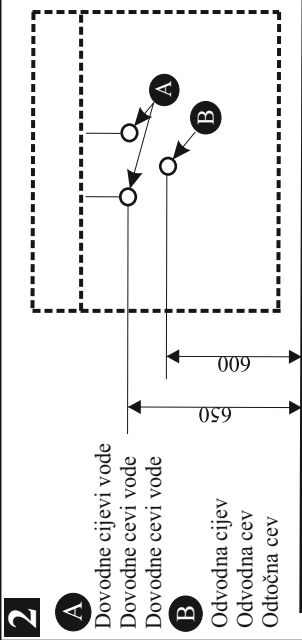

1



2

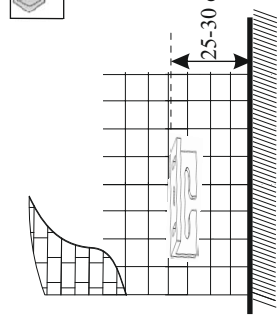

3

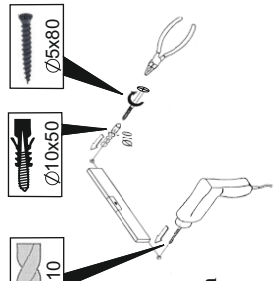

4

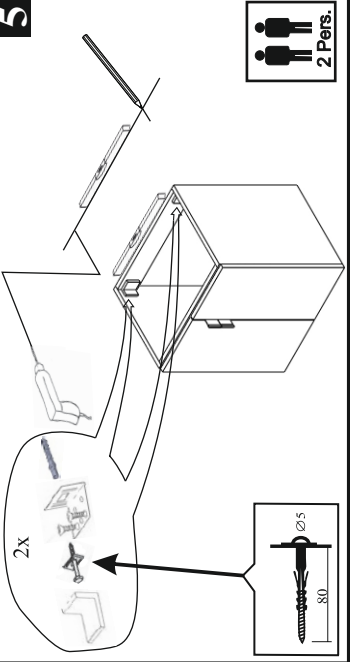

5

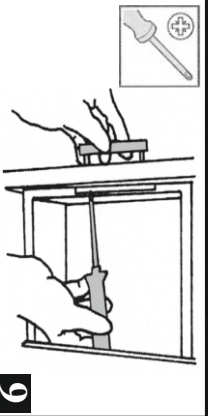

6

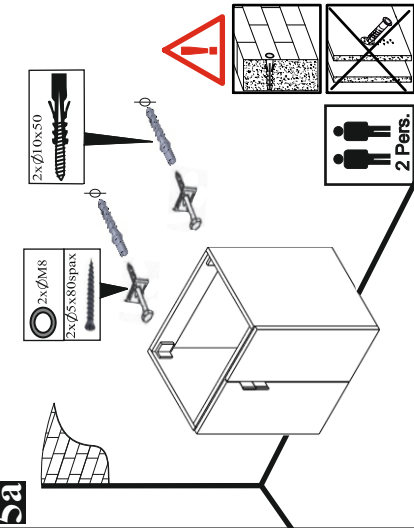

5a

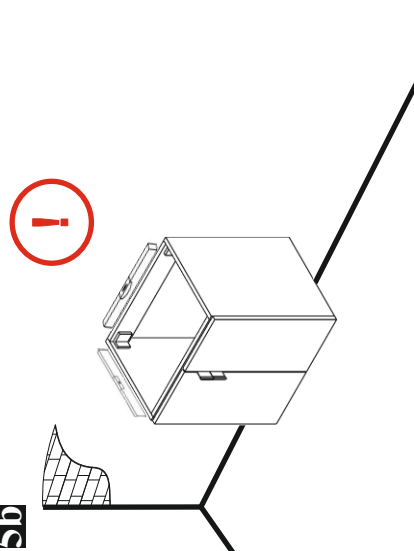

5b

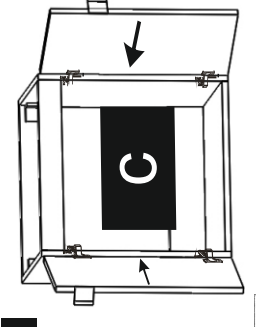

7

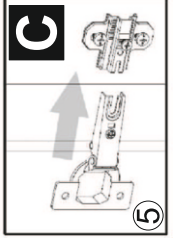

C

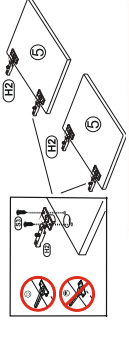

5

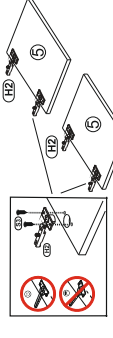

5

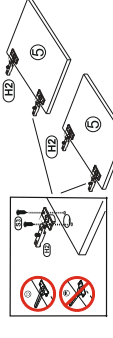

5

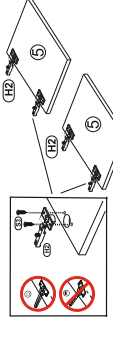

5

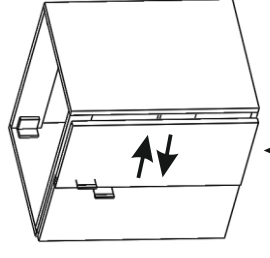

8

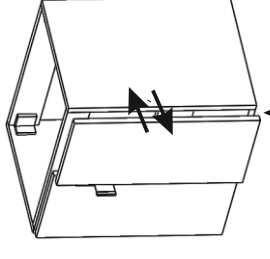

8

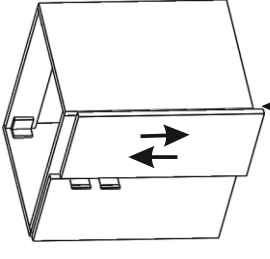

8

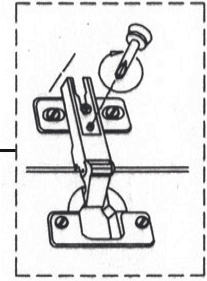

9

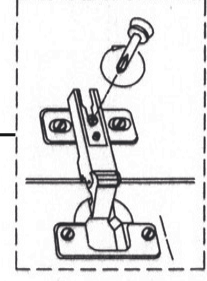

9

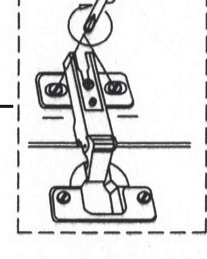

9

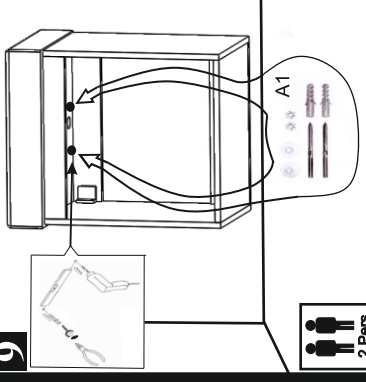

9a

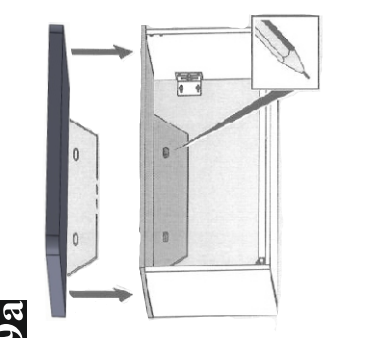

9b

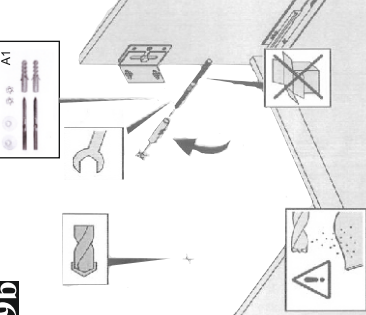

9c

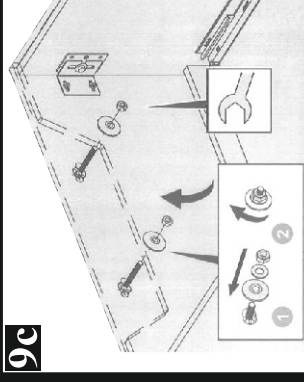

9c

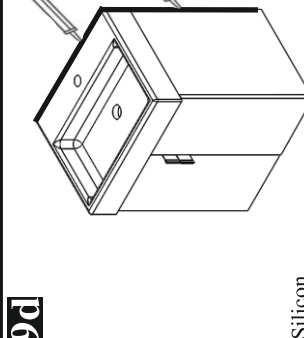

9d

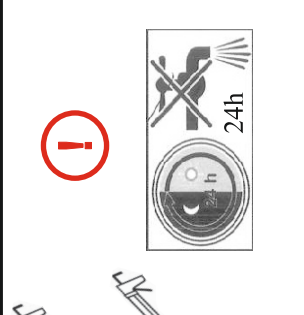

9d

Siicon



!