

HR BHT GARANCIJSKI USLUGI

- 1. Za proizvod upisan u ovaj garancijski list proizvođač daje 24 mjeseca garanciju...
2. Proizvođač jamči da će proizvod u garancijskom roku funkcionirati bez greške pod uvjetom da se kupac pridržava uputstva za upotrebu...

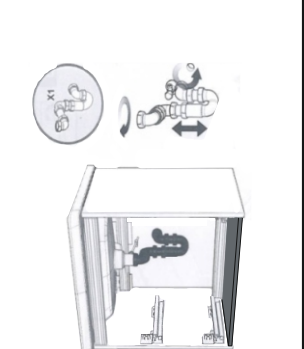

SR MNF JUSLOW GARANCIJE

- 1. Za proizvod naveden u ovom garantnom listu proizvođač daje 24 mjeseca garanciju...
2. Proizvođač jamči da će proizvod u garantnom roku besprijekorno funkcionirati ako korisnik bude postupao po uputama proizvođača...

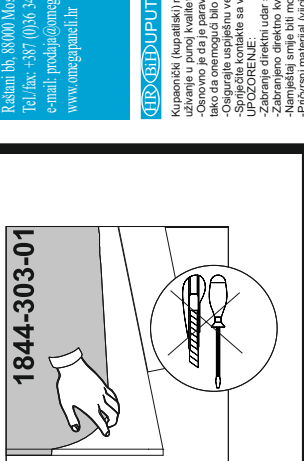

STO GARANCIJSKI POGOJI

- 1. Za izdelek, vpisan v tem garancijskem listu, daje proizvajalec 24 mesecev garancijski rok...
2. Proizvajalec jamci, da bo izdelek v garancijskem roku brezurno funkcionalen, da se bo uporabnik navpil po danih navodilih proizvajalca...



TIPI TYPE 142

- 1x
4x Ø18
4x Ø5x80spax
4x Ø10x50
2x Ø4x10spax
60 min.
2 Pers.
Silicon
nije uključeno ne uključuje
Sifon

Ovlaštenik servis za podnožje Hrvatske, EU OMEGA PANELI d.o.o.
Ul. Neznanji, jankica 143,
81000 PODGORICA, CRNA GORA
Tel: +385 (0) 33 15 730
Fax: +385 (0) 33 99 801
e-mail: prodaja@omegapaneli.hr

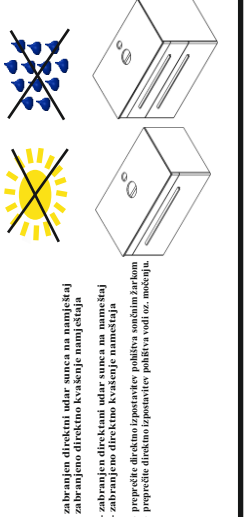
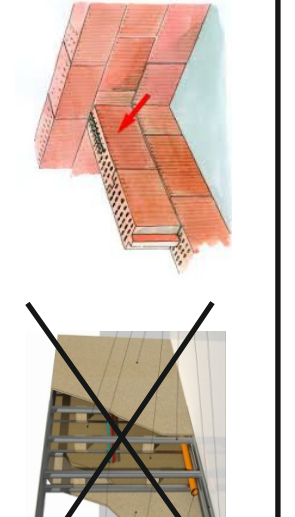
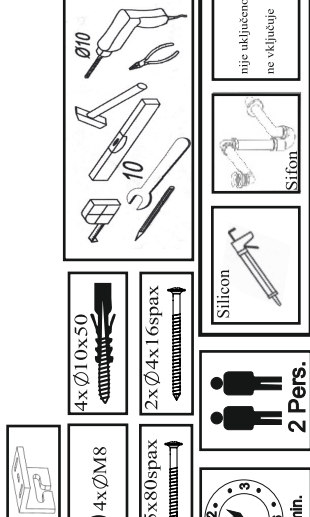
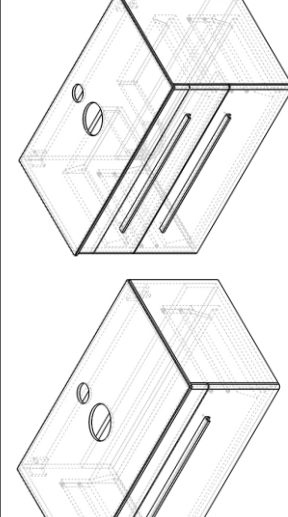
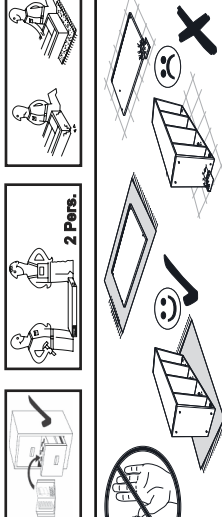

Proizvođači ovlaštenik servis za podnožje BiH OMEGA PANELI d.o.o.
Rastini bh. 8W00 Moslar, Bostai i Hercegovina
Tel/fax: +387 (0)36 346 392
e-mail: prodaja@omegapaneli.hr
www.omegapaneli.hr

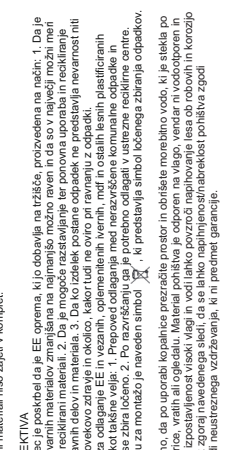
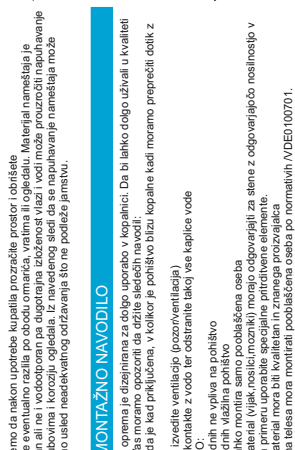
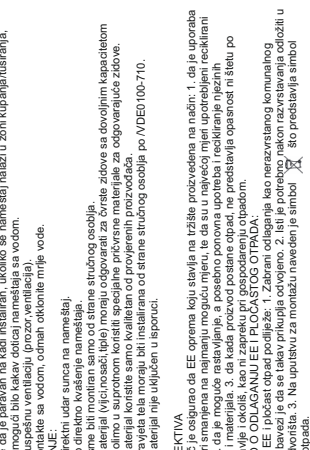
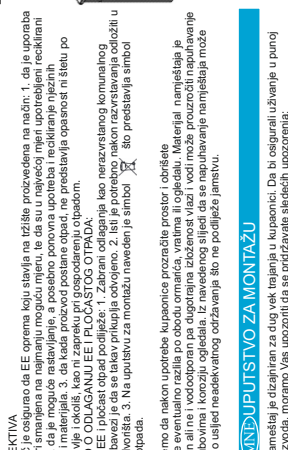
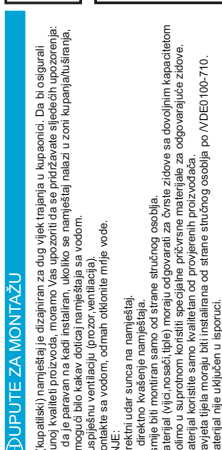

Ovlaštenik servis za podnožje Crne Gore KIPS d.o.o. Podgorica
Ul. Neznanji, jankica 143,
81000 PODGORICA, CRNA GORA
Tel: +382 77 600 106

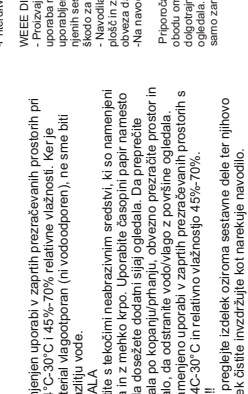
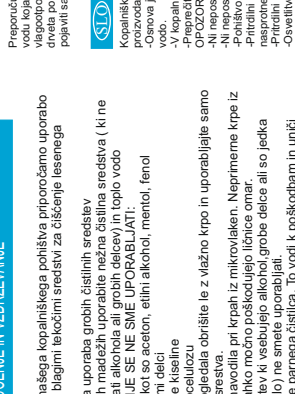
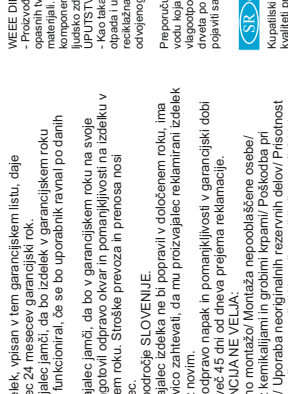
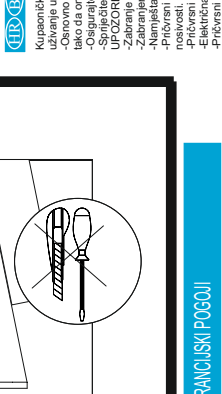

Ovlaštenik servis za podnožje Hrvatske, EU OMEGA PANELI d.o.o.
Ul. Neznanji, jankica 143,
81000 PODGORICA, CRNA GORA
Tel: +385 (0) 33 15 730
Fax: +385 (0) 33 99 801
e-mail: prodaja@omegapaneli.hr

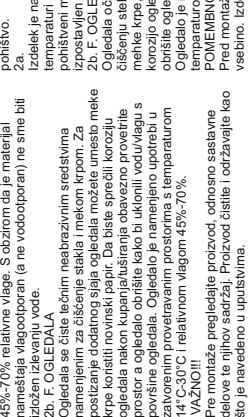
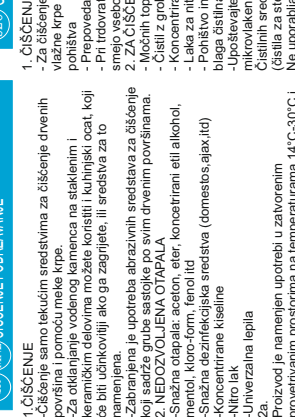
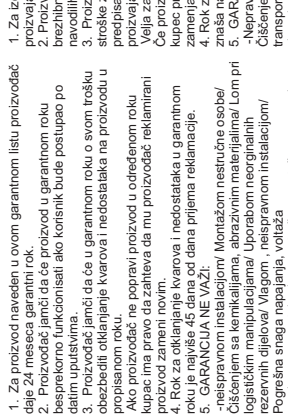
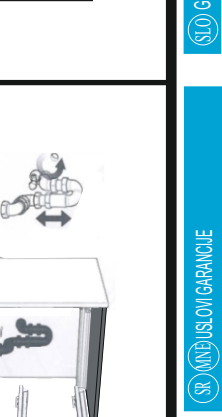

Ovlaštenik servis za podnožje Hrvatske, EU OMEGA PANELI d.o.o.
Ul. Neznanji, jankica 143,
81000 PODGORICA, CRNA GORA
Tel: +385 (0) 33 15 730
Fax: +385 (0) 33 99 801
e-mail: prodaja@omegapaneli.hr

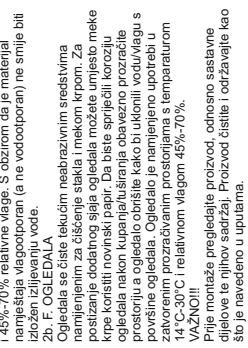
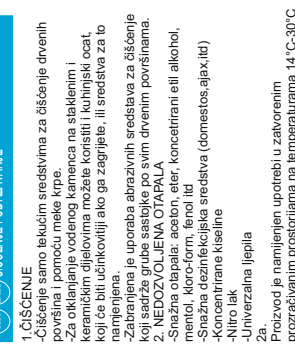
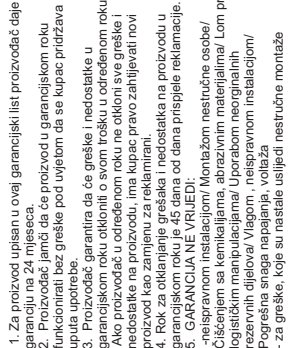
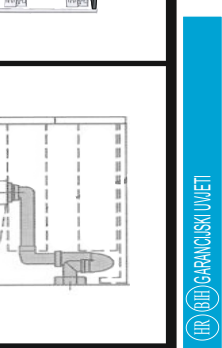

**Instalacija mora biti urađena po normi DIN EN 14749**

**Nameštitev mora biti merojan po DIN EN 14749**

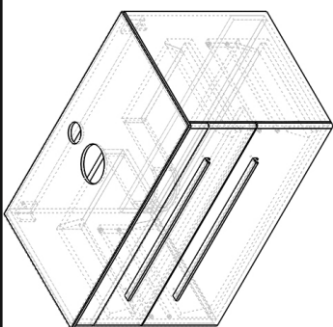

**1**

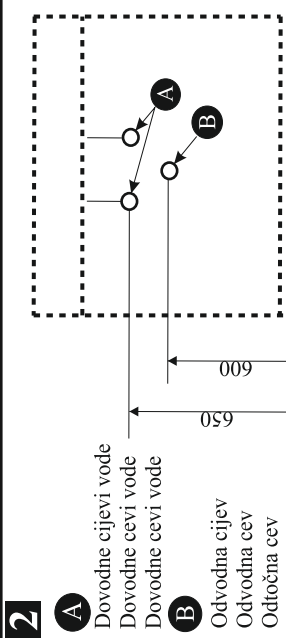

**2**

- A** Dovodne cijevi vode  
Dovodne cevi vode
- B** Odvodna cijev  
Odvodna cev  
Odtočna cev

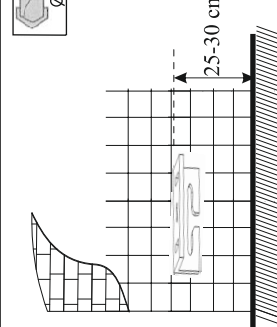

**3**

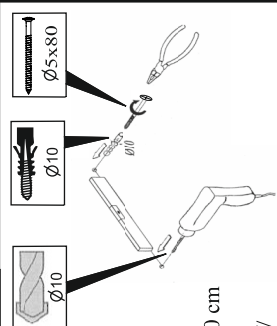

**4**

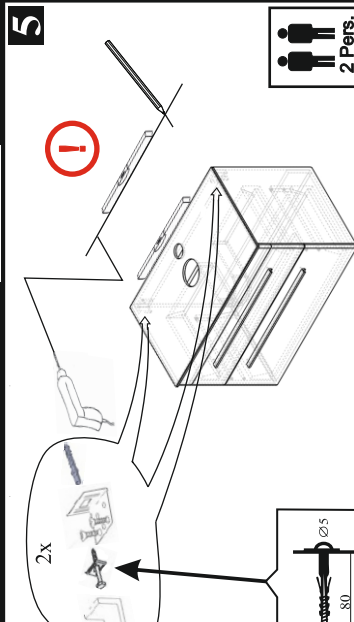

**5**

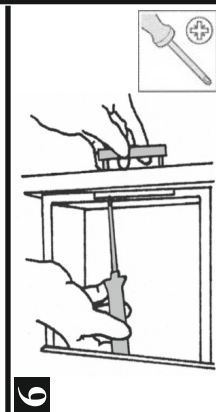

**6**

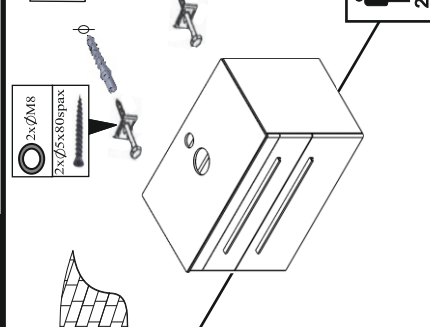

**5a**

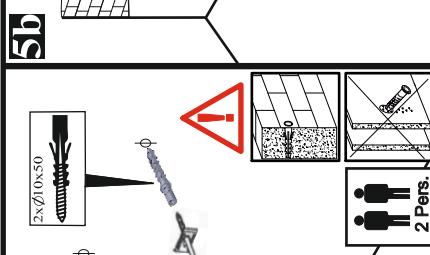

**5b**

**7**

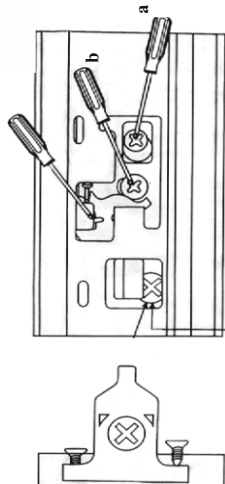
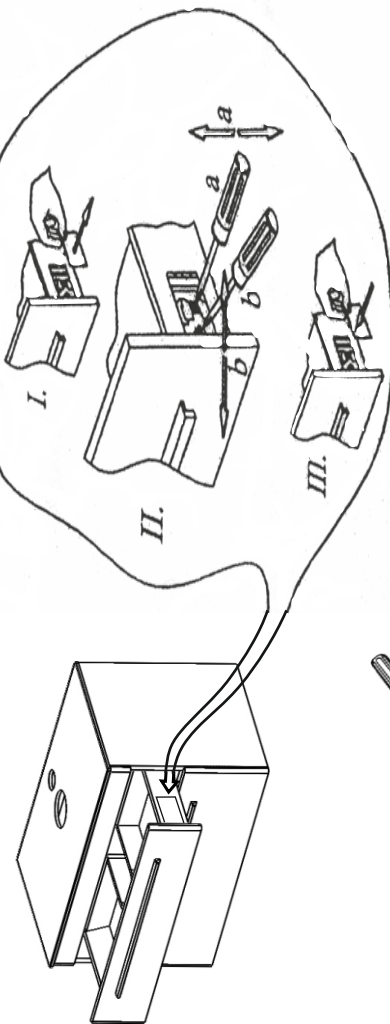

**8**

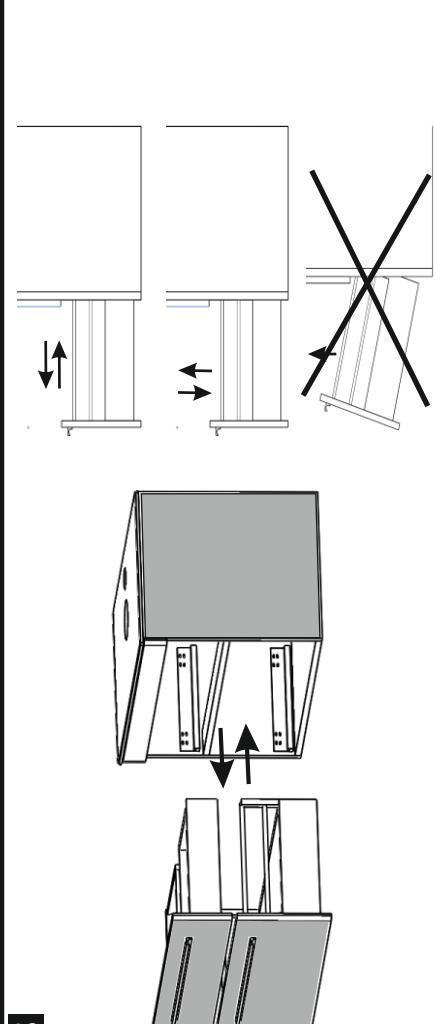

**9**

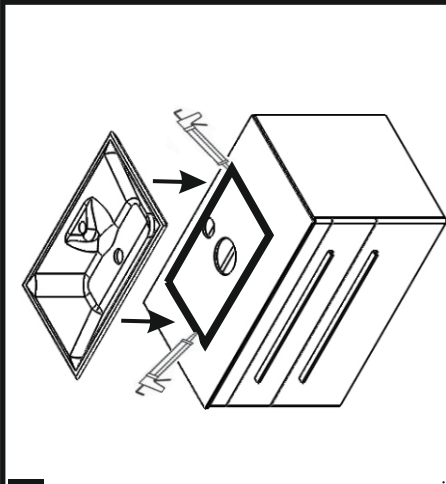

**9a**

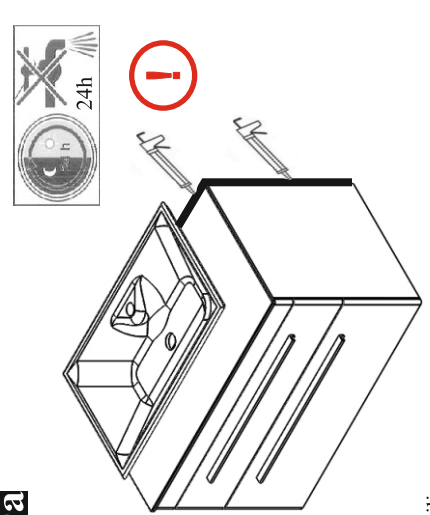

Silicon

Silicon