

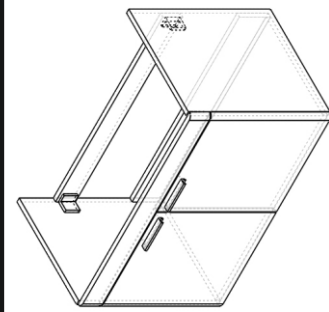

**Instalacija mora biti urađena po normi DIN EN 14749**

**Nameštitev mora biti merejan po DIN EN 14749**



**1**

**2**

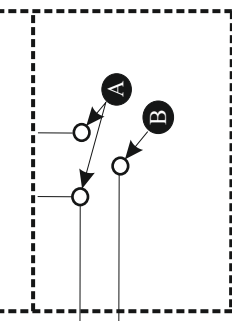

- A** Dovodne cijevi vode  
Dovodne cevi vode
- B** Odvodna cijev  
Odvodna cev  
Odtočna cev

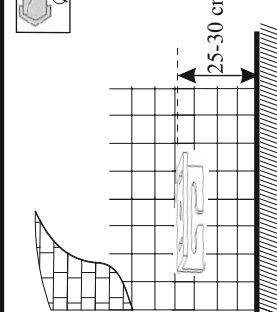

**3**

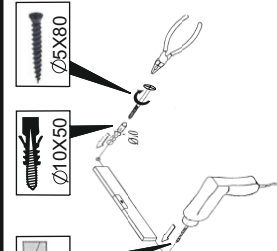

**4**

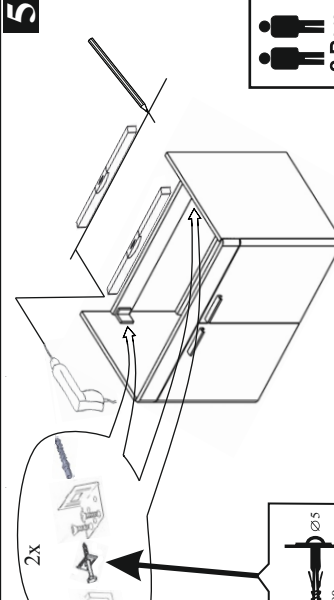

**5**

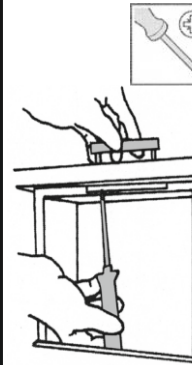

**6**

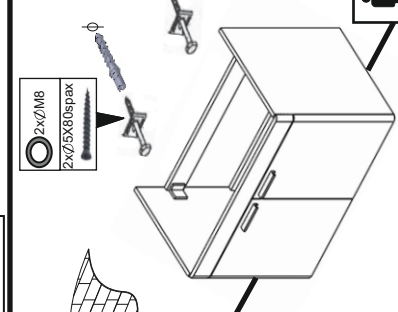

**5a**

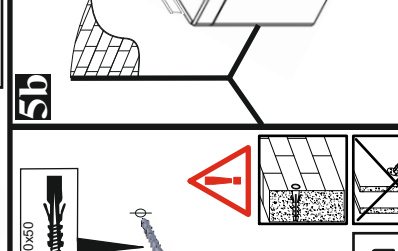

**5b**

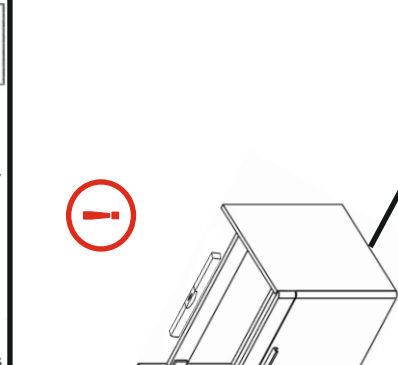

**9b**

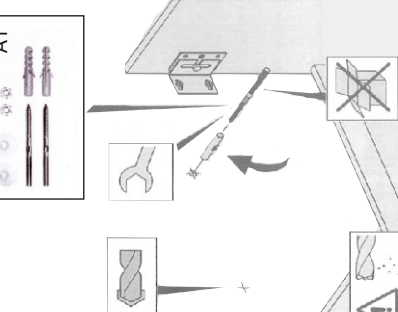

**9c**

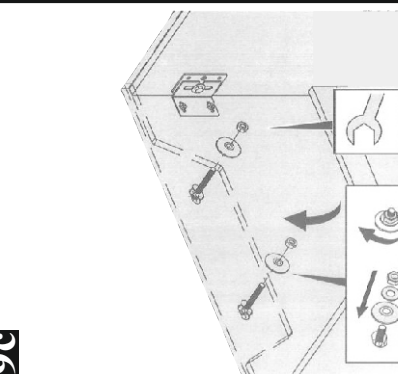

**9d**

Silicon

**7**

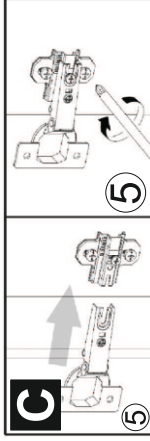

**7**

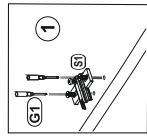

**8**

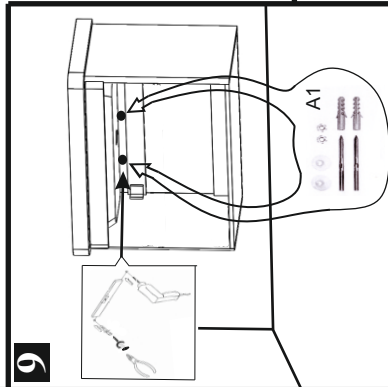

**9**

**9a**

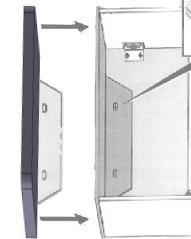

2 Pers.

**9a**

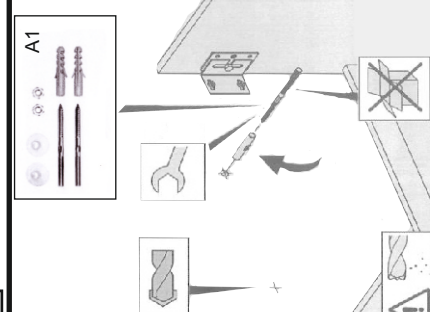

**9b**

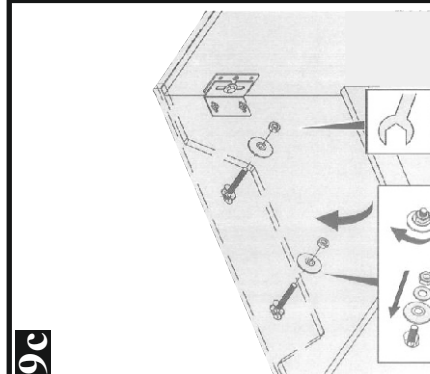

**9c**

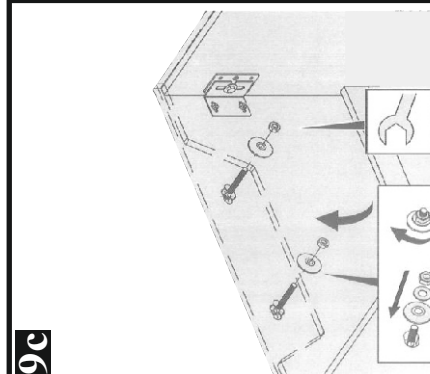

**9d**



24h

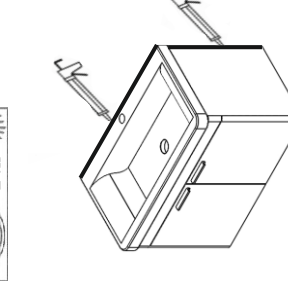

**9e**